

A stylized graphic of a flame, composed of large, overlapping shapes in a vibrant orange and a dark charcoal grey. The flame is oriented vertically, with the base at the bottom and the top reaching towards the upper left corner of the frame. The overall effect is bold and modern.

FIREGEAR

2022 Product Guide



Kalea Bay



OUTDOOR LINEAR GAS FIREPLACE

Kalea Bay



Make a modern statement with the all-new Kalea Bay LED & Non-LED outdoor linear gas fireplace. Designed with a clean and contemporary style in mind. No chimney or venting required makes it an ideal product for quick & efficient framing & finishing.



Features

- LED Models: Full spectrum lighting (120VAC Required).
- LED Model Sizes: 32" / 48" / 60" / 72" (all 16" tall opening).
- Non-LED Models: Battery-operated Ignition.
- Non-LED Model Sizes: 48" / 60" (all 16" tall opening).
- Burner & firebox constructed of weather/corrosion resistant 304 stainless steel.
- Ecoflow Electronic Ignition System features built-in safety shutoff in case of loss of flame and auto-relight.
- Control Center with each model housed in 304 Stainless Steel Cabinet.
- Ships as Natural Gas (NG) or Liquid Propane (LP). Field Convertible to Liquid Propane (LP). Conversion Kits sold separately.
- Tested & Approved to: ANSI Z21.97-2014/CSA 2.41-2014 standards.

LED Models



Controls:

On / Off, Low / High, Continuous Pilot, Learn & LED On/Off

Use the RGB dials to get your desired color, there are over 16 million to choose from!



NON-LED Models



Controls:

On / Off, Low / High, Continuous Pilot, & Learn.

Easy access to the battery tray makes maintenance for the Kalea Bay a breeze.



C Batteries (4)



Kalea Bay | LED Models

Model	Size	Gas Type	BTU Low	BTU High	Conv. Kit	Weather Cover
OFP-36LECO-NLED	36"	NG	18,500	31,000	OFP-36LECO-LPK	OFP-36COV
OFP-36LECO-PLED	36"	LP	18,500	31,000	OFP-36LECO-LPK	OFP-36COV
OFP-48LECO-NLED	48"	NG	24,500	43,500	OFP-48LECO-LPK	OFP-48COV
OFP-48LECO-PLED	48"	LP	24,500	43,500	OFP-48LECO-LPK	OFP-48COV
OFP-60LECO-NLED	60"	NG	36,000	50,000	OFP-60LECO-LPK	OFP-60COV
OFP-60LECO-PLED	60"	LP	36,000	50,000	OFP-60LECO-LPK	OFP-60COV
OFP-72LECO-NLED	72"	NG	42,000	65,000	OFP-72LECO-LPK	OFP-72COV
OFP-72LECO-PLED	72"	LP	42,000	65,000	OFP-72LECO-LPK	OFP-72COV



Kalea Bay | NON-LED Models

Model	Size	Gas Type	BTU Low	BTU High	Conv. Kit	Weather Cover
OFP-48LECO-N	48"	NG	24,500	43,500	OFP-48LECO-LPK	OFP-48COV
OFP-48LECO-P	48"	LP	24,500	43,500	OFP-48LECO-LPK	OFP-48COV
OFP-60LECO-N	60"	NG	36,000	50,000	OFP-60LECO-LPK	OFP-60COV
OFP-60LECO-P	60"	LP	36,000	50,000	OFP-60LECO-LPK	OFP-60COV

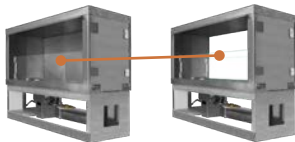

See-Through Conversion Kits

The Kalea Bay ships single sided, but you can convert to See-Through!

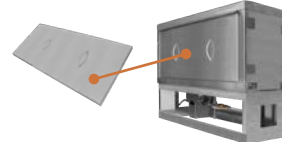

Weather Cover

Our covers are made of 304 Stainless Steel and are available for each size.

Model	Description
78002	2020 BUILT - 36" Kalea Bay LED (OFP-36LECO-NLED) See-Through Conversion Kit includes: 2-Piece Glass Windshield Kit and Stainless Steel Hood, LED Tray with LED Strip
78004	2020 BUILT 48" Kalea Bay LED (OFP-48LECO-NLED) See-Through Conversion Kit includes: 2-Piece Glass Windshield Kit and Stainless Steel Hood, LED Tray with LED Strip
78006	2020 BUILT 60" Kalea Bay LED (OFP-60LECO-NLED) See-Through Conversion Kit includes: 2-Piece Glass Windshield Kit and Stainless Steel Hood, LED Tray with LED Strip
78008	2020 BUILT 72" Kalea Bay LED (OFP-72LECO-NLED) See-Through Conversion Kit includes: 2-Piece Glass Windshield Kit and Stainless Steel Hood, LED Tray with LED Strip
78010	2020 BUILT 48" Kalea Bay NON-LED (OFP-48LECO-N) See-Through Conversion Kit includes: 2-Piece Glass Windshield Kit, Windshield Support and Stainless Steel Hood
78011	2020 BUILT 60" Kalea Bay NON-LED (OFP-60LECO-N) See-Through Conversion Kit includes: 2-Piece Glass Windshield Kit, Windshield Support and Stainless Steel Hood

Model	Description
OFP-36COV	36" Kalea Bay Weather Cover - Constructed of 304 Stainless Steel
OFP-48COV	48" Kalea Bay Weather Cover - Constructed of 304 Stainless Steel
OFP-60COV	60" Kalea Bay Weather Cover - Constructed of 304 Stainless Steel
OFP-72COV	72" Kalea Bay Weather Cover - Constructed of 304 Stainless Steel

Installation Accessories

Model	Description
77111	10' long, 6-pin LED Extension wire harness - for LED Models only
77161	10' long, 8-pin Mod Extension wire harness for LED and Non-LED Models
VCS-ECOBUEXT120	2-pin battery pack extension wire to extend the wire on a battery pack of the NON-LED Kalea Bay.

GLASS MEDIA FOR BURNERS SOLD SEPARATELY
FOR AVAILABLE GLASS & ROCK MEDIA SEE PAGE 19



Sanctuary Series



SANCTUARY SERIES

Ignition Systems



ALL WEATHER ELECTRONIC SYSTEM

AWS Systems

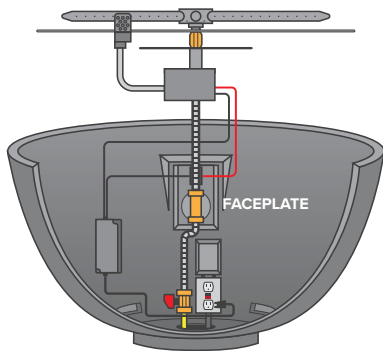

Our top of the line fully electronic ignition system. Ships with a GEO-30VDC power supply and an on/off toggle switch.

THERMOCOUPLE PILOTED SAFETY (SPARK IGNITION)

TPSI Systems

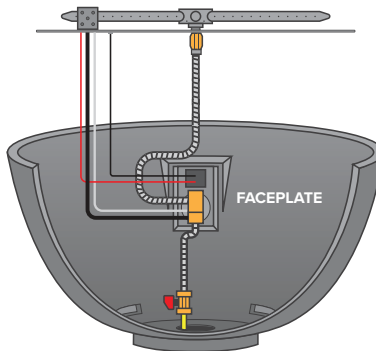

Battery operated manual spark ignition system using a variable flame control knob. Safety valve turns gas off in case of flame loss.

MATCH THROW

MT Systems

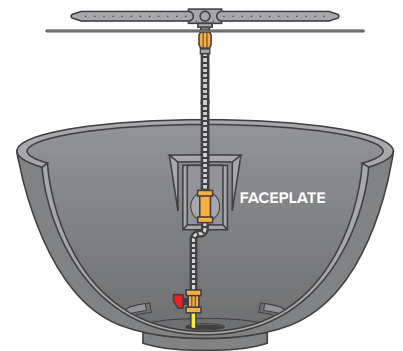

Easy lighting with a butane lighter or match. Variable flame height adjustment using a key valve.

Weather Cover



Protect your fire feature with our heavy-duty PVC covers, 100 percent water-resistant, UV-Protected to prevent fading, custom fitted, and feature soft flannel backing (to keep your fire feature scratch free).

Propane Tank Holder



Holds one (1) 20 lb. tank. Easy to remove top. Weight: 159 lb. Dimensions: 20" W x 21 1/2" H



Sanctuary 1

The Sanctuary 1 comes in 4 different colors (listed below) as well as two different sizes. The weather cover is included.



In the model numbers below, replace the **XX** with your desired color code.

Colors listed above are representations and may not reflect actual colors received. **Color chip samples available check with your locale dealer or distributor for availability.**

Model	Ignition	Size	Gas Type	BTU	LP Conversion Kit	Weather Cover
SAN1-30LHAWS-*XX	AWS	56" L x 38" W x 16" H	NG - Choose between N or P for the "**" in the model number	75,000	OAS-LPK31 + FG-AWS-PBO-P	COVER-SAN1
SAN1-30LHTPSI-XX	TPSI	56" L x 38" W x 16" H	NG - For LP add "-P" to the end of the model number	75,000	TPSI-LPK41	COVER-SAN1
NEW SAN176-30LHTPSI-XX	TPSI	76" L x 38" W x 16" H	NG - For LP add "-P" to the end of the model number	125,000	TPSI-LPK31	Coming Soon



Sanctuary 2

The Sanctuary 2 comes in 4 different colors (listed below) as three different ignition systems. Weather cover is included.



In the model numbers below, replace the **XX** with your desired color code.

Colors listed above are representations and may not reflect actual colors received. **Color chip samples available check with your locale dealer or distributor for availability.**

Model	Ignition	Size	Gas Type	BTU	LP Conversion Kit	Weather Cover
SAN2-34DBSAWS-N-XX	AWS	39" Diameter x 18" H	NG - Propane Conv. Kits available	75,000	OAS-LPK31 + FG-AWS-PBO-P	COVER-SAN2
NEW SAN2-34DBSTPSI-XX	TPSI	39" Diameter x 18" H	NG	75,000	TPSI-LPK41	COVER-SAN2
NEW SAN2-34DBSTPSI-XX-P	TPSI	39" Diameter x 18" H	LP	75,000	TPSI-LPK41	COVER-SAN2
SAN2-34DBSMT-XX	MT	39" Diameter x 18" H	NG - Propane Conv. Kits available	75,000	OAS-LPK41	COVER-SAN2



Sanctuary 3

The Sanctuary 3 comes in 4 different colors (listed below) as three different ignition systems. Weather cover is included.



In the model numbers below, replace the **XX** with your desired color code.

Colors listed above are representations and may not reflect actual colors received. **Color chip samples available check with your locale dealer or distributor for availability.**

Model	Ignition	Size	Gas Type	BTU	LP Conversion Kit	Weather Cover
SAN3-26DBSAWS-N-XX	AWS	29" Diameter x 14" H	NG - Propane Conv. Kits available	75,000	OAS-LPK31 + FG-AWS-PBO-P	COVER-SAN3
NEW SAN3-26DBSTPSI-XX	TPSI	29" Diameter x 14" H	NG	75,000	TPSI-LPK41	COVER-SAN3
NEW SAN3-26DBSTPSI-XX-P	TPSI	29" Diameter x 14" H	LP	75,000	TPSI-LPK41	COVER-SAN3
SAN3-26DBSMT-XX	MT	29" Diameter x 14" H	NG - Propane Conv. Kits available	75,000	OAS-LPK41	COVER-SAN3

MEDIA FOR BURNERS SOLD SEPARATELY
FOR AVAILABLE GLASS & ROCK MEDIA SEE PAGE 19



Ignition Systems

AWS ALL WEATHER ELECTRONIC IGNITION SYSTEM

WEATHER RESISTANT

Single Fire Feature

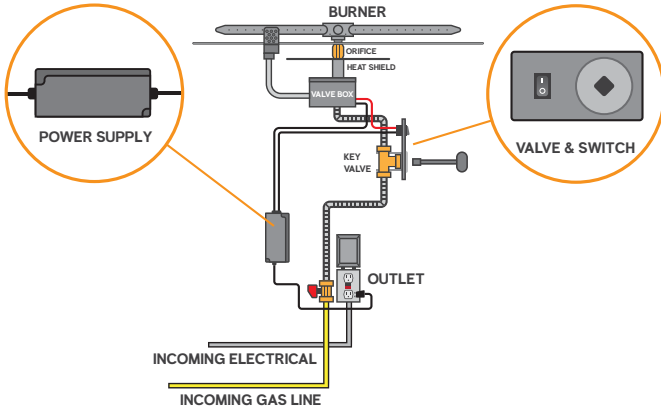

How it Lights

If you chose an FPB or LOF system (see page 8 & 10), the system lights by pressing the toggle switch on the faceplate.

MULTIPLE FIRE FEATURES, POOL CERTIFIED, & WEATHER RESISTANT

Multiple Fire Features

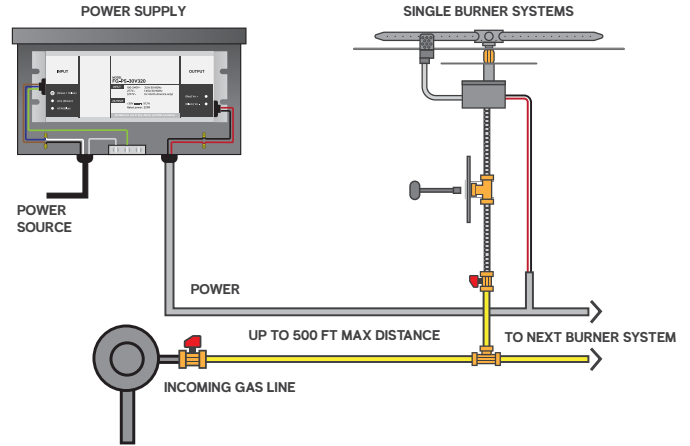

How it Lights

If you choose our A La Carte System, the way to operate your fire features are endless! See page 7 to learn more about the A La Carte Purchasing System!

TPSI THERMOCOUPLE PILOTED SAFETY IGNITION

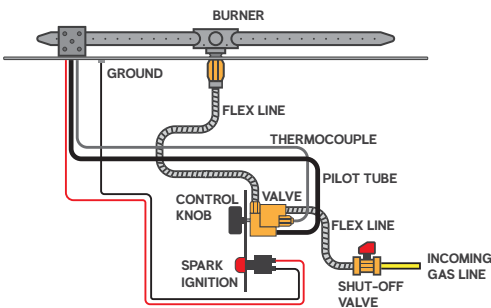

Overview

- Thermocouple Piloted System with Safety Valve turns gas off when loss of flame
- Easy ignition with Battery Spark Igniter (included)
- TPSI system with Safety Valve turn gas off when pilot flame goes out
- Robust ignition system with full BTU throughput

MT MATCH THROW

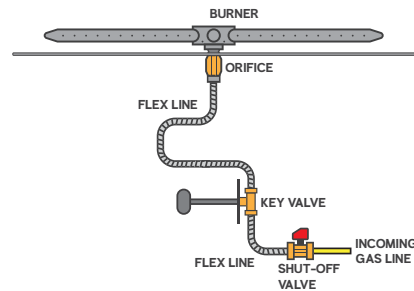

Overview

- Most popular ignition system, least amount of cost
- Light a match or a butane lighter
- Can be used in residential installs
- This system is the easiest to use, and with non-listed burners you can achieve high BTU's and big flames.

AWS A La Carte Purchase System

Single Fire Feature

- Used for a single fire feature.
- Can only be installed in fire features that are greater than 10 feet away from a pool or spa.
- All components can be housed underneath the burner.

Model	Description
FG-AWS30VDC-GOEK-N	Includes: FG-SCNG-30VDC Valve System, 30" Pilot Assembly, Heat Shield, Wire Leads, Hardware Bag, GOE-30VDC Power Supply, On/Off Weatherproof Rocker Switch and Stainless Steel Mounting Plate - 290K BTU NG (replaces part # FG-AWS30VDC-RCK)
FG-AWS30VDC-GOEK-P	Includes: FG-SCNG-30VDC Valve System, 30" Pilot Assembly, Heat Shield, Wire Leads, Hardware Bag, GOE-30VDC Power Supply, On/Off Weatherproof Rocker Switch and Stainless Steel Mounting Plate - 290K BTU LP (replaces part # FG-AWS30VDC-RCK)
AWS-FACEPLATE	Stainless Steel Faceplate (only) for AWS Valve Systems for mounting Key Valve and ON/OFF Weatherproof Switch
FG-AWS-HARDWARE-BAG	Hardware bag for all AWS valve systems 

Ignition & Accessories FOR SINGLE & MULTIPLE AWS

	
FG-EMER-STOP Electrical Emergency Stop for 120VAC or 30VDC Appliances, housed in Weatherproof J-Box and Weatherproof Cover	FG-TIMER-2HR 120VAC Two (2) Hour Mechanical Timer, housed in Weatherproof J-Box and Weatherproof Cover
	
FG-WS-OD 120VAC Wired Wall Switch housed in Weatherproof J-Box and Weatherproof Cover	FG-1420-AOD 1420-A (On/Off/Remote) with 110 Receiver. With weatherproof J-Box and weatherproof cover
	
GEO-30VDC	FG-AWS-PS-30V320

Multiple Fire Features

- Used when running 1 - 4 fire features. Also used when running a single or multiple fire features within 5 feet of a pool / spa.
- One kit per fire feature. One power supply (sold separately) for every 4 fire features.

Model	Description
FG-AWS30VDC-HC-K-N	NEW HIGHER BTU: FG-HCNG-30VDC Valve System, High Capacity Natural Gas Valve System - 3/4 FIP Inlet, 3/4 FIP Outlet, 30" Pilot Assembly, Mounting Plate for High Capacity Key Valve (3/4" IPS straight Valve with Key) and On/Off Weatherproof Rocker Switch, Heat Shield, Mounting Hardware, Wire 10' AWS Power Wire to Valve, T300-9898-34 (5/8" OD, 1/2" ID Tranquiline Gas Flex Connector, 3/4" Stainless Steel Close Nipple, 5/8" Flare x 3/4" MIP Steel Adapter (Tapped 1/2 FIP), Power Supply and Orifice Not Included - 715K BTU NG
FG-AWS30VDC-HC-K-P	NEW HIGHER BTU: FG-HCNG-30VDC Valve System, High Capacity Natural Gas Valve System - 3/4 FIP Inlet, 3/4 FIP Outlet, 30" Pilot Assembly, Mounting Plate for High Capacity Key Valve (3/4" IPS straight Valve with Key) and On/Off Weatherproof Rocker Switch, Heat Shield, Mounting Hardware, Wire 10' AWS Power Wire to Valve, T300-9898-34 (5/8" OD, 1/2" ID Tranquiline Gas Flex Connector, 3/4" Stainless Steel Close Nipple, 5/8" Flare x 3/4" MIP Steel Adapter (Tapped 1/2 FIP), Power Supply and Orifice Not Included - 715K BTU LP
FG-AWS30VDC-K-N	290K BTU Capacity 30VDC Valve System for Natural Gas - 1/2 FIP Inlet, 1/2 FIP Outlet, 30" Pilot Assembly, Mounting Plate for High Capacity Key Valve (3/4" IPS straight Valve with Key) and On/Off Weatherproof Rocker Switch, Heat Shield, Mounting Hardware, Wire 10' AWS Power Wire to Valve, T200-9898-46 (1/2" OD, 3/8" ID Tranquiline Gas Flex Connector, Stainless Steel Coupler, 1/2" Flare x 1/2" MIP Steel Adapter (Tapped 1/2 FIP), Power Supply and Orifice Not Included - 290K BTU NG
FG-AWS30VDC-K-P	290K BTU Capacity 30VDC Valve System for Liquid Propane - 1/2 FIP Inlet, 1/2 FIP Outlet, 30" Pilot Assembly, Mounting Plate for High Capacity Key Valve (3/4" IPS straight Valve with Key) and On/Off Weatherproof Rocker Switch, Heat Shield, Mounting Hardware, Wire 10' AWS Power Wire to Valve, T200-9898-46 (1/2" OD, 3/8" ID Tranquiline Gas Flex Connector, Stainless Steel Coupler, 1/2" Flare x 1/2" MIP Steel Adapter (Tapped 1/2 FIP), Power Supply and Orifice Not Included - 290K BTU LP
FG-AWS-PS-30V320	30VDC, 320W Power Supply - POOL CERTIFIED - built into NEMA Approved Enclosure - for use with single installation or up to four fire features, max distance run of 500' - Replaces FG-PS-30V320
AWS-FACEPLATE	Stainless Steel Faceplate (only) for AWS Valve Systems for mounting Key Valve and ON/OFF Weatherproof Switch
FG-AWS-HARDWARE-BAG	Hardware bag for all AWS valve systems 

✦ Pro Series: Burner Kits

EACH BURNER & BURNER KIT ARE DESIGNED TO BE NATURAL GAS OR PROPANE FROM THE FACTORY.

WE DO NOT OFFER GAS CONVERSION KITS FOR PRO SERIES

Burning Spur Kits PRO SERIES



Model	Size	BTU
FG-PSBR-BS10-LPK	10"	95,000
FG-PSBR-BS10-NGK	10"	80,000
FG-PSBR-BS14-LPK	14"	160,000
FG-PSBR-BS14-NGK	14"	125,000
FG-PSBR-BS21-LPK	21"	175,000
FG-PSBR-BS21-NGK	21"	175,000

Burning Spurs PRO SERIES



Model	Size	BTU
FG-PSBR-BS10-LP	10"	95,000
FG-PSBR-BS10-NG	10"	80,000
FG-PSBR-BS14-LP	14"	160,000
FG-PSBR-BS14-NG	14"	125,000
FG-PSBR-BS21-LP	21"	175,000
FG-PSBR-BS21-NG	21"	175,000

H Burner Kits PRO SERIES



Model	Size	BTU
FG-PSBR-H24-LPK	24" x 6.75"	110,000
FG-PSBR-H24-NGK	24" x 6.75"	80,000
FG-PSBR-H30-LPK	30" x 6.75"	115,000
FG-PSBR-H30-NGK	30" x 6.75"	95,000
FG-PSBR-H40-LPK	40" x 6.75"	150,000
FG-PSBR-H40-NGK	40" x 6.75"	120,000
FG-PSBR-H50-LPK	50" x 6.75"	175,000
FG-PSBR-H50-NGK	50" x 6.75"	160,000
FG-PSBR-H60-LPK	60" x 6.75"	200,000
FG-PSBR-H60-NGK	60" x 6.75"	180,000
FG-PSBR-H80-LPK	80" x 6.75"	240,000
FG-PSBR-H80-NGK	80" x 6.75"	250,000

H Burners PRO SERIES



Model	Size	BTU
FG-PSBR-H24-LP	24" x 6.75"	110,000
FG-PSBR-H24-NG	24" x 6.75"	80,000
FG-PSBR-H30-LP	30" x 6.75"	115,000
FG-PSBR-H30-NG	30" x 6.75"	95,000
FG-PSBR-H40-LP	40" x 6.75"	150,000
FG-PSBR-H40-NG	40" x 6.75"	120,000
FG-PSBR-H50-LP	50" x 6.75"	175,000
FG-PSBR-H50-NG	50" x 6.75"	160,000
FG-PSBR-H60-LP	60" x 6.75"	200,000
FG-PSBR-H60-NG	60" x 6.75"	180,000
FG-PSBR-H80-LP	80" x 6.75"	240,000
FG-PSBR-H80-NG	80" x 6.75"	250,000

T Burner Kits PRO SERIES



Model	Size	BTU
FG-PSBR-T24-LPK	24"	50,000
FG-PSBR-T24-NGK	24"	50,000
FG-PSBR-T38-LPK	38"	90,000
FG-PSBR-T38-NGK	38"	90,000
FG-PSBR-T44-LPK	44"	100,000
FG-PSBR-T44-NGK	44"	100,000
FG-PSBR-T56-LPK	56"	135,000
FG-PSBR-T56-NGK	56"	135,000
FG-PSBR-T68-LPK	68"	140,000
FG-PSBR-T68-NGK	68"	140,000
FG-PSBR-T86-LPK	86"	145,000
FG-PSBR-T86-NGK	86"	145,000
FG-PSBR-T90-LPK	90"	165,000
FG-PSBR-T90-NGK	90"	165,000
FG-PSBR-T110-LPK	110"	185,000
FG-PSBR-T110-NGK	110"	185,000
FG-PSBR-T122-LPK	122"	200,000
FG-PSBR-T122-NGK	122"	200,000

T Burners PRO SERIES



Model	Size	BTU
FG-PSBR-T24-LP	24"	50,000
FG-PSBR-T24-NG	24"	50,000
FG-PSBR-T38-LP	38"	90,000
FG-PSBR-T38-NG	38"	90,000
FG-PSBR-T44-LP	44"	100,000
FG-PSBR-T44-NG	44"	100,000
FG-PSBR-T56-LP	56"	135,000
FG-PSBR-T56-NG	56"	135,000
FG-PSBR-T68-LP	68"	140,000
FG-PSBR-T68-NG	68"	140,000
FG-PSBR-T86-LP	86"	145,000
FG-PSBR-T86-NG	86"	145,000
FG-PSBR-T90-LP	90"	165,000
FG-PSBR-T90-NG	90"	165,000
FG-PSBR-T110-LP	110"	185,000
FG-PSBR-T110-NG	110"	185,000
FG-PSBR-T122-LP	122"	200,000
FG-PSBR-T122-NG	122"	200,000

✦ Stainless Steel: Burner Kits

ALL STAINLESS STEEL BURNERS & BURNER KITS SHIP AS NATURAL GAS.

Burning Spur Kits STAINLESS STEEL

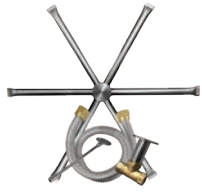

Model	Size	BTU	LP Conv.
DBS-12K	12"	50,000	OAS-LPK47
DBS-16K	16"	75,000	OAS-LPK41
DBS-22K	22"	125,000	OAS-LPK31
DBS-31K	31"	175,000	OAS-LPK26
DBS-36K	36"	250,000	OAS-LPK12

Burning Spurs STAINLESS STEEL



Model	Size	BTU	LP Conv.
DBS-12	12"	50,000	OAS-LPK47
DBS-16	16"	75,000	OAS-LPK41
DBS-22	22"	125,000	OAS-LPK31
DBS-31	31"	175,000	OAS-LPK26
DBS-36	36"	250,000	OAS-LPK12

H Burner Kits STAINLESS STEEL



Model	Size	BTU	LP Conv.
FG-H-2406SSK	24" x 6"	75,000	OAS-LPK41
FG-H-3006SSK	30" x 6"	100,000	OAS-LPK35
FG-H-3606SSK	36" x 6"	125,000	OAS-LPK31
FG-H-4806SSK	48" x 6"	175,000	OAS-LPK26



Model	Size	BTU	LP Conv.
FG-H-2110SSK	21" x 10"	75,000	OAS-LPK41
FG-H-2710SSK	27" x 10"	100,000	OAS-LPK35
FG-H-3310SSK	33" x 10"	125,000	OAS-LPK31
FG-H-4510SSK	45" x 10"	150,000	OAS-LPK29
FG-H-5710SSK	57" x 10"	175,000	OAS-LPK26
FG-H-6910SSK	69" x 10"	200,000	OAS-LPK22
FG-H-8110SSK	81" x 10"	225,000	OAS-LPK19
FG-H-9310SSK	93" x 10"	250,000	OAS-LPK12

H Burners STAINLESS STEEL



Model	Size	BTU	LP Conv.
FG-H-2406SS	24" x 6"	75,000	OAS-LPK41
FG-H-3006SS	30" x 6"	100,000	OAS-LPK35
FG-H-3606SS	36" x 6"	125,000	OAS-LPK31
FG-H-4806SS	48" x 6"	175,000	OAS-LPK26



Model	Size	BTU	LP Conv.
FG-H-2110SS	21" x 10"	75,000	OAS-LPK41
FG-H-2710SS	27" x 10"	100,000	OAS-LPK35
FG-H-3310SS	33" x 10"	125,000	OAS-LPK31
FG-H-4510SS	45" x 10"	150,000	OAS-LPK29
FG-H-5710SS	57" x 10"	175,000	OAS-LPK26
FG-H-6910SS	69" x 10"	200,000	OAS-LPK22
FG-H-8110SS	81" x 10"	225,000	OAS-LPK19
FG-H-9310SS	93" x 10"	250,000	OAS-LPK12

T Burner Kits STAINLESS STEEL



Model	Size	BTU	LP Conv.
FG-T-21SSK	21"	50,000	OAS-LPK47
FG-T-27SSK	27"	50,000	OAS-LPK47
FG-T-33SSK	33"	75,000	OAS-LPK41
FG-T-45SSK	45"	100,000	OAS-LPK35
FG-T-57SSK	57"	125,000	OAS-LPK31
FG-T-69SSK	69"	150,000	OAS-LPK29
FG-T-81SSK	81"	175,000	OAS-LPK26
FG-T-93SSK	93"	200,000	OAS-LPK22

T Burners STAINLESS STEEL



Model	Size	BTU	LP Conv.
FG-T-21SS	21"	50,000	OAS-LPK47
FG-T-27SS	27"	50,000	OAS-LPK47
FG-T-33SS	33"	75,000	OAS-LPK41
FG-T-45SS	45"	100,000	OAS-LPK35
FG-T-57SS	57"	125,000	OAS-LPK31
FG-T-69SS	69"	150,000	OAS-LPK29
FG-T-81SS	81"	175,000	OAS-LPK26
FG-T-93SS	93"	200,000	OAS-LPK22

Fire Ring Kits STAINLESS STEEL



Model	Size	BTU	LP Conv.
FG-FR-6SSK	6"	50,000	OAS-LPK27
FG-FR-12SSK	12"	50,000	OAS-LPK47
FG-FR-18SSK	18"	75,000	OAS-LPK47
FG-FR-24SSK	24"	125,000	OAS-LPK41
FG-FR-30SSK	30"	250,000	OAS-LPK31
FG-FR-36SSK	36"	250,000	OAS-LPK12
FG-FR-48SSK	48"	250,000	OAS-LPK12

Fire Rings STAINLESS STEEL



Model	Size	BTU	LP Conv.
FG-FR-6SS	6"	50,000	OAS-LPK27
FG-FR-12SS	12"	50,000	OAS-LPK47
FG-FR-18SS	18"	75,000	OAS-LPK47
FG-FR-24SS	24"	125,000	OAS-LPK41
FG-FR-30SS	30"	250,000	OAS-LPK31
FG-FR-36SS	36"	250,000	OAS-LPK12
FG-FR-48SS	48"	250,000	OAS-LPK12



Pro Series Burner Systems

○ Round Drop-In **AWS**



Model	Pan Size	BTU
FPB-19RPSBR14AWS-N	19"	80,000
FPB-19RPSBR14AWS-P	19"	95,000
FPB-25RPSBR21AWS-N	25"	175,000
FPB-25RPSBR21AWS-P	25"	175,000
FPB-29RPSBR21AWS-N	29"	175,000
FPB-29RPSBR21AWS-P	29"	175,000
FPB-33RPSBR21AWS-N	33"	175,000
FPB-33RPSBR21AWS-P	33"	175,000

○ Round Flat **AWS**



Model	Pan Size	BTU
FPB-26DPSBR21AWS-N	26"	175,000
FPB-26DPSBR21AWS-P	26"	175,000
FPB-29DPSBR21AWS-N	29"	175,000
FPB-29DPSBR21AWS-P	29"	175,000
FPB-34DPSBR21AWS-N	34"	175,000
FPB-34DPSBR21AWS-P	34"	175,000

○ Round Drop-In **TPSI**



Model	Pan Size	BTU
FPB-19RPSBR14TPSI-N	19"	125,000
FPB-19RPSBR14TPSI-P	19"	160,000
FPB-25RPSBR21TPSI-N	25"	175,000
FPB-25RPSBR21TPSI-P	25"	175,000
FPB-29RPSBR21TPSI-N	29"	175,000
FPB-29RPSBR21TPSI-P	29"	175,000
FPB-33RPSBR21TPSI-N	33"	175,000
FPB-33RPSBR21TPSI-P	33"	175,000

○ Round Flat **TPSI**



Model	Pan Size	BTU
FPB-26DPSBR21TPSI-N	26"	175,000
FPB-26DPSBR21TPSI-P	26"	175,000
FPB-29DPSBR21TPSI-N	29"	175,000
FPB-29DPSBR21TPSI-P	29"	175,000
FPB-34DPSBR21TPSI-N	34"	175,000
FPB-34DPSBR21TPSI-P	34"	175,000

○ Round Drop-In **MT**



Model	Pan Size	BTU
FPB-19RPSBR14MT-N	19"	125,000
FPB-19RPSBR14MT-P	19"	160,000
FPB-25RPSBR21MT-N	25"	125,000
FPB-25RPSBR21MT-P	25"	160,000
FPB-29RPSBR21MT-N	29"	175,000
FPB-29RPSBR21MT-P	29"	175,000
FPB-33RPSBR21MT-N	33"	175,000
FPB-33RPSBR21MT-P	33"	175,000

○ Round Flat **MT**



Model	Pan Size	BTU
FPB-26DPSBR21MT-N	26"	175,000
FPB-26DPSBR21MT-P	26"	175,000
FPB-29DPSBR21MT-N	29"	175,000
FPB-29DPSBR21MT-P	29"	175,000
FPB-34DPSBR21MT-N	34"	175,000
FPB-34DPSBR21MT-P	34"	175,000

□ Square Drop-In **AWS**



Model	Pan Size	BTU
FPB-20SPSBR14AWS-N	20"	125,000
FPB-20SPSBR14AWS-P	20"	160,000
FPB-26SPSBR21AWS-N	25"	175,000
FPB-26SPSBR21AWS-P	25"	175,000
FPB-32SPSBR21AWS-N	32"	175,000
FPB-32SPSBR21AWS-P	32"	175,000

□ Square Flat **AWS**

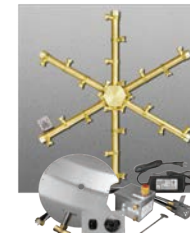

Model	Pan Size	BTU
FPB-25SFPSBR21AWS-N	25"	175,000
FPB-25SFPSBR21AWS-P	25"	175,000
FPB-30SFPSBR21AWS-N	30"	175,000
FPB-30SFPSBR21AWS-P	30"	175,000
FPB-34SFPSBR21AWS-N	34"	175,000
FPB-34SFPSBR21AWS-P	34"	175,000

EACH PRO BURNER SYSTEM IS DESIGNED TO BE NATURAL GAS OR PROPANE FROM THE FACTORY.

WE DO NOT OFFER GAS CONVERSION KITS FOR PRO SERIES BURNER SYSTEMS.

□ Square **↳ Drop-In** **TPSI**



Model	Pan Size	BTU
FPB-20SPSBR14TPSI-N	20"	125,000
FPB-20SPSBR14TPSI-P	20"	160,000
FPB-26SPSBR21TPSI-N	26"	175,000
FPB-26SPSBR21TPSI-P	26"	175,000
FPB-32SPSBR21TPSI-N	32"	175,000
FPB-32SPSBR21TPSI-P	32"	175,000

□ Square **— Flat** **TPSI**



Model	Pan Size	BTU
FPB-25SFPSBR21TPSI-N	25"	175,000
FPB-25SFPSBR21TPSI-P	25"	175,000
FPB-30SFPSBR21TPSI-N	30"	175,000
FPB-30SFPSBR21TPSI-P	30"	175,000
FPB-34SFPSBR21TPSI-N	34"	175,000
FPB-34SFPSBR21TPSI-P	34"	175,000

□ Square **↳ Drop-In** **MT**



Model	Pan Size	BTU
FPB-20SPSBR14MT-N	20"	125,000
FPB-20SPSBR14MT-P	20"	160,000
FPB-26SPSBR21MT-N	26"	175,000
FPB-26SPSBR21MT-P	26"	175,000
FPB-32SPSBR21MT-N	32"	175,000
FPB-32SPSBR21MT-P	32"	175,000

□ Square **— Flat** **MT**



Model	Pan Size	BTU
FPB-25SFPSBR21MT-N	25"	175,000
FPB-25SFPSBR21MT-P	25"	175,000
FPB-30SFPSBR21MT-N	30"	175,000
FPB-30SFPSBR21MT-P	30"	175,000
FPB-34SFPSBR21MT-N	34"	175,000
FPB-34SFPSBR21MT-P	34"	175,000

□ Linear **— Flat** **AWS**



Model	Pan Size	BTU
LOF-3010PS246AWS-N	30" x 10"	80,000
LOF-3010PS246AWS-P	30" x 10"	110,000
LOF-3610PS306AWS-N	36" x 10"	95,000
LOF-3610PS306AWS-P	36" x 10"	115,000
LOF-4810PS406AWS-N	48" x 10"	120,000
LOF-4810PS406AWS-P	48" x 10"	150,000
LOF-6010PS506AWS-N	60" x 10"	160,000
LOF-6010PS506AWS-P	60" x 10"	175,000
LOF-7210PS606AWS-N	72" x 10"	180,000
LOF-7210PS606AWS-P	72" x 10"	200,000
LOF-9610PS806AWS-N	96" x 10"	250,000
LOF-9610PS806AWS-P	96" x 10"	240,000

□ Linear **— Flat** **MT**



Model	Pan Size	BTU
LOF-3010PS246MT-N	30" x 10"	80,000
LOF-3010PS246MT-P	30" x 10"	110,000
LOF-3610PS306MT-N	36" x 10"	95,000
LOF-3610PS306MT-P	36" x 10"	115,000
LOF-4810PS406MT-N	48" x 10"	120,000
LOF-4810PS406MT-P	48" x 10"	150,000
LOF-6010PS506MT-N	60" x 10"	160,000
LOF-6010PS506MT-P	60" x 10"	175,000
LOF-7210PS606MT-N	72" x 10"	180,000
LOF-7210PS606MT-P	72" x 10"	200,000
LOF-9610PS806MT-N	96" x 10"	250,000
LOF-9610PS806MT-P	96" x 10"	240,000

□ Linear **— Flat** **TPSI**



Model	Pan Size	BTU
LOF-3010PS246TPSI-N	30" x 10"	80,000
LOF-3010PS246TPSI-P	30" x 10"	110,000
LOF-3610PS306TPSI-N	36" x 10"	95,000
LOF-3610PS306TPSI-P	36" x 10"	115,000
LOF-4810PS406TPSI-N	48" x 10"	120,000
LOF-4810PS406TPSI-P	48" x 10"	150,000
LOF-6010PS506TPSI-N	60" x 10"	160,000
LOF-6010PS506TPSI-P	60" x 10"	175,000



Stainless Steel Burner Systems

Made in the USA

Round Drop-In

AWS



Model	Pan Size	BTU
FPB-25RBSAWS-N	25"	125,000
FPB-25RBSAWS-P	25"	125,000
FPB-29RBSAWS-N	29"	125,000
FPB-29RBSAWS-P	29"	125,000
FPB-33RBSAWS-N	33"	175,000
FPB-33RBSAWS-P	33"	175,000

Round Flat

AWS



Model	Pan Size	BTU
FPB-26DBSAWS-N	26"	125,000
FPB-26DBSAWS-P	26"	125,000
FPB-29DBSAWS-N	29"	125,000
FPB-29DBSAWS-P	29"	125,000
FPB-34DBSAWS-N	34"	175,000
FPB-34DBSAWS-P	34"	175,000
FPB-39DBSAWS-N	39"	250,000
FPB-39DBSAWS-P	39"	250,000
FPB-44DBSAWS-N	44"	250,000
FPB-44DBSAWS-P	44"	250,000

Round Drop-In

TPSI



Model	Pan Size	BTU
FPB-19RBS16TPSI-N	19"	75,000
FPB-19RBS16TPSI-P	19"	75,000
FPB-25RBS22TPSI-N	25"	125,000
FPB-25RBS22TPSI-P	25"	125,000
FPB-29RBS22TPSI-N	29"	125,000
FPB-29RBS22TPSI-P	29"	125,000
FPB-33RBS31TPSI-N	33"	150,000
FPB-33RBS31TPSI-P	33"	150,000

Round Flat

TPSI



Model	Pan Size	BTU
FPB-26DBS22TPSI-N	26"	125,000
FPB-26DBS22TPSI-P	26"	125,000
FPB-29DBS22TPSI-N	29"	125,000
FPB-29DBS22TPSI-P	29"	125,000
FPB-34DBS31TPSI-N	34"	150,000
FPB-34DBS31TPSI-P	34"	150,000

Round Drop-In

MT



Model	Pan Size	BTU
FPB-16RBSMT-N	16"	50,000
FPB-19RBSMT-N	19"	75,000
FPB-25RBS22MT-N	25"	125,000
FPB-29RBS22MT-N	29"	125,000
FPB-33RBS31MT-N	33"	175,000

Round Flat

MT



Model	Pan Size	BTU
FPB-26DBS22MT-N	26"	125,000
FPB-29DBS22MT-N	29"	125,000
FPB-34DBS31MT-N	34"	175,000
FPB-39DBS36MT-N	39"	250,000
FPB-44DBS36MT-N	44"	250,000

Conversion Kits
FROM NATURAL GAS TO PROPANE



□ Square **↳ Drop-In** **AWS**



Model	Pan Size	BTU
FPB-20SBSAWS-N	20"	75,000
FPB-20SBSAWS-P	20"	75,000
FPB-26SBSAWS-N	26"	125,000
FPB-26SBSAWS-P	26"	125,000
FPB-32SBSAWS-N	32"	175,000
FPB-32SBSAWS-P	32"	175,000
FPB-38SBSAWS-N	38"	250,000
FPB-38SBSAWS-P	38"	250,000

□ Square **— Flat** **AWS**



Model	Pan Size	BTU
FPB-25SFBSAWS-N	25"	125,000
FPB-25SFBSAWS-P	25"	125,000
FPB-30SFBSAWS-N	30"	125,000
FPB-30SFBSAWS-P	30"	125,000
FPB-34SFBSAWS-N	34"	175,000
FPB-34SFBSAWS-P	34"	175,000
FPB-40SFBSAWS-N	40"	250,000
FPB-40SFBSAWS-P	40"	250,000
FPB-46SFBSAWS-N	46"	250,000
FPB-46SFBSAWS-P	46"	250,000

□ Square **↳ Drop-In** **TPSI**



Model	Pan Size	BTU
FPB-20SBS16TPSI-N	20"	75,000
FPB-20SBS16TPSI-P	20"	75,000
FPB-26SBS22TPSI-N	26"	125,000
FPB-26SBS22TPSI-P	26"	125,000
FPB-32SBS31TPSI-N	32"	150,000
FPB-32SBS31TPSI-P	32"	150,000

□ Square **— Flat** **TPSI**



Model	Pan Size	BTU
FPB-25SFBS22TPSI-N	25"	125,000
FPB-25SFBS22TPSI-P	25"	125,000
FPB-30SFBS22TPSI-N	30"	125,000
FPB-30SFBS22TPSI-P	30"	125,000
FPB-34SFBS31TPSI-N	34"	150,000
FPB-34SFBS31TPSI-P	34"	175,000

□ Square **↳ Drop-In** **MT**



Model	Pan Size	BTU
FPB-20SPSBR14MT-N	20"	75,000
FPB-20SPSBR14MT-P	26"	125,000
FPB-26SPSBR21MT-N	32"	175,000
FPB-26SPSBR21MT-P	38"	250,000

□ Square **— Flat** **MT**



Model	Pan Size	BTU
FPB-25SFBS22MT-N	25"	125,000
FPB-30SFBS22MT-N	30"	125,000
FPB-34SFBS31MT-N	34"	175,000
FPB-40SFBS36MT-N	40"	250,000
FPB-46SFBS36MT-N	46"	250,000

Conversion Kits
FROM NATURAL GAS TO PROPANE





Stainless Steel Burner Systems

Made in the USA

Linear - H Drop-In

AWS



Model	Pan Size	BTU
LOF-2412HAWS-N	24" x 12"	50,000
LOF-2412HAWS-P	24" x 12"	50,000
LOF-3012HAWS-N	30" x 12"	100,000
LOF-3012HAWS-P	30" x 12"	100,000
LOF-3614HAWS-N	36" x 14"	125,000
LOF-3614HAWS-P	36" x 14"	125,000
LOF-4214HAWS-N	42" x 14"	150,000
LOF-4214HAWS-P	42" x 14"	150,000
LOF-4814HAWS-N	48" x 14"	150,000
LOF-4814HAWS-P	48" x 14"	150,000
LOF-6016HAWS-N	60" x 16"	175,000
LOF-6016HAWS-P	60" x 16"	175,000
LOF-7216HAWS-N	72" x 16"	200,000
LOF-7216HAWS-P	72" x 16"	200,000
LOF-8416HAWS-N	84" x 16"	225,000
LOF-8416HAWS-P	84" x 16"	225,000
LOF-9616HAWS-N	96" x 16"	250,000
LOF-9616HAWS-P	96" x 16"	250,000

Linear - H Flat

AWS



Model	Pan Size	BTU
LOF-2414FHAWS-N	24" x 14"	50,000
LOF-2414FHAWS-P	24" x 14"	50,000
LOF-3014FHAWS-N	30" x 14"	75,000
LOF-3014FHAWS-P	30" x 14"	75,000
LOF-3614FHAWS-N	36" x 14"	100,000
LOF-3614FHAWS-P	36" x 14"	100,000
LOF-4814FHAWS-N	48" x 14"	150,000
LOF-4814FHAWS-P	48" x 14"	150,000
LOF-6016FHAWS-N	60" x 16"	175,000
LOF-6016FHAWS-P	60" x 16"	175,000
LOF-7216FHAWS-N	72" x 16"	200,000
LOF-7216FHAWS-P	72" x 16"	200,000
LOF-8416FHAWS-N	84" x 16"	225,000
LOF-8416FHAWS-P	84" x 16"	225,000
LOF-9616FHAWS-N	96" x 16"	250,000
LOF-9616FHAWS-P	96" x 16"	250,000

Linear - H Drop-In

TPSI



Model	Pan Size	BTU
LOF-2412HTPSI-N	24" x 12"	75,000
LOF-2412HTPSI-P	24" x 12"	75,000
LOF-3012HTPSI-N	30" x 12"	100,000
LOF-3012HTPSI-P	30" x 12"	100,000
LOF-3614HTPSI-N	36" x 14"	125,000
LOF-3614HTPSI-P	36" x 14"	125,000
LOF-4214HTPSI-N	42" x 14"	125,000
LOF-4214HTPSI-P	42" x 14"	125,000
LOF-4814HTPSI-N	48" x 14"	150,000
LOF-4814HTPSI-P	48" x 14"	150,000

Linear - H Flat

TPSI



Model	Pan Size	BTU
LOF-2414FHTPSI-N	24" x 14"	75,000
LOF-2414FHTPSI-P	24" x 14"	75,000
LOF-3014FHTPSI-N	30" x 14"	125,000
LOF-3014FHTPSI-P	30" x 14"	125,000
LOF-3614FHTPSI-N	36" x 14"	125,000
LOF-3614FHTPSI-P	36" x 14"	125,000
LOF-4814FHTPSI-N	48" x 14"	150,000
LOF-4814FHTPSI-P	48" x 14"	150,000

Linear - H Drop-In

MT



Model	Pan Size	BTU
LOF-2412HMT-N	24" x 12"	75,000
LOF-3012HMT-N	30" x 12"	100,000
LOF-3614HMT-N	36" x 14"	125,000
LOF-4214HMT-N	42" x 14"	150,000
LOF-4814HMT-N	48" x 14"	150,000
LOF-6016HMT-N	60" x 16"	175,000
LOF-7216HMT-N	72" x 16"	200,000
LOF-8416HMT-N	84" x 16"	225,000
LOF-9616HMT-N	96" x 16"	250,000

Linear - H Flat

MT



Model	Pan Size	BTU
LOF-2414FHTPSI-N	24" x 14"	75,000
LOF-2414FHTPSI-P	30" x 14"	100,000
LOF-3014FHTPSI-N	36" x 14"	125,000
LOF-3014FHTPSI-P	48" x 14"	150,000
LOF-3614FHTPSI-N	60" x 16"	175,000
LOF-3614FHTPSI-P	72" x 16"	200,000
LOF-4814FHTPSI-N	84" x 16"	225,000
LOF-4814FHTPSI-P	96" x 16"	250,000

Conversion Kits
FROM NATURAL GAS TO PROPANE



Linear - T Drop-In AWS



Model	Pan Size	BTU
LOF-2406TAWS-N	24" x 6"	50,000
LOF-2406TAWS-P	24" x 6"	50,000
LOF-3006TAWS-N	30" x 6"	50,000
LOF-3006TAWS-P	30" x 6"	50,000
LOF-3606TAWS-N	36" x 6"	75,000
LOF-3606TAWS-P	36" x 6"	75,000
LOF-4806TAWS-N	48" x 6"	100,000
LOF-4806TAWS-P	48" x 6"	100,000
LOF-6006TAWS-N	60" x 6"	125,000
LOF-6006TAWS-P	60" x 6"	125,000
LOF-7206TAWS-N	72" x 6"	150,000
LOF-7206TAWS-P	72" x 6"	150,000
LOF-8406TAWS-N	84" x 6"	175,000
LOF-8406TAWS-P	84" x 6"	175,000
LOF-9606TAWS-N	96" x 6"	200,000
LOF-9606TAWS-P	96" x 6"	200,000

Linear - T Flat AWS



Model	Pan Size	BTU
LOF-4808FTAWS-N	48" x 8"	100,000
LOF-4808FTAWS-P	48" x 8"	100,000
LOF-6008FTAWS-N	60" x 8"	125,000
LOF-6008FTAWS-P	60" x 8"	125,000
LOF-7208FTAWS-N	72" x 8"	150,000
LOF-7208FTAWS-P	72" x 8"	150,000
LOF-8408FTAWS-N	84" x 8"	175,000
LOF-8408FTAWS-P	84" x 8"	175,000
LOF-9608FTAWS-N	96" x 8"	200,000
LOF-9608FTAWS-P	96" x 8"	200,000

Linear - T Drop-In TPSI



Model	Pan Size	BTU
LOF-2406TTPSI-N	24" x 6"	50,000
LOF-2406TTPSI-P	24" x 6"	50,000
LOF-3006TTPSI-N	30" x 6"	50,000
LOF-3006TTPSI-P	30" x 6"	50,000
LOF-3606TTPSI-N	36" x 6"	75,000
LOF-3606TTPSI-P	36" x 6"	75,000
LOF-4806TTPSI-N	48" x 6"	100,000
LOF-4806TTPSI-P	48" x 6"	100,000
LOF-6006TTPSI-N	60" x 6"	125,000
LOF-6006TTPSI-P	60" x 6"	150,000
LOF-7206TTPSI-N	72" x 6"	150,000
LOF-7206TTPSI-P	72" x 6"	150,000

Linear - T Flat TPSI



Model	Pan Size	BTU
LOF-4808FTTPSI-N	48" x 8"	100,000
LOF-4808FTTPSI-P	48" x 8"	100,000
LOF-6008FTTPSI-N	60" x 8"	125,000
LOF-6008FTTPSI-P	60" x 8"	125,000
LOF-7208FTTPSI-N	72" x 8"	150,000
LOF-7208FTTPSI-P	72" x 8"	150,000

Linear - T Drop-In MT



Model	Pan Size	BTU
LOF-2406TMT-N	24" x 6"	50,000
LOF-3006TMT-N	30" x 6"	50,000
LOF-3606TMT-N	36" x 6"	75,000
LOF-4806TMT-N	48" x 6"	100,000
LOF-6006TMT-N	60" x 6"	125,000
LOF-7206TMT-N	72" x 6"	150,000
LOF-8406TMT-N	84" x 6"	175,000
LOF-9606TMT-N	96" x 6"	200,000

Linear - T Flat MT



Model	Pan Size	BTU
LOF-4808FTMT-N	48" x 8"	100,000
LOF-6008FTMT-N	60" x 8"	125,000
LOF-7208FTMT-N	72" x 8"	150,000
LOF-8408FTMT-N	84" x 8"	175,000
LOF-9608FTMT-N	96" x 8"	200,000

Conversion Kits
FROM NATURAL GAS TO PROPANE





SRW/Paver FPB Packages



Stainless Steel SRW/Paver Kits

One model number - each package provides the all-in-one solution for upgrading to a gas fire pit.

All models are sold in either Natural Gas or Liquid Propane from the factory.

To the right you will find a representation of what's in the box of each package.



BURNER SYSTEM



FLEX FRAME



CONTROL PANEL



VENT KIT



MEDIA

Round — Flat

MT

Model	Fits Inside Diameter	Burner System	Flexframe	Control Panel	Vent Kit	Media	LP Conv.
FPB-26D22MTN-PK	26" to 29"	FPB-26DBS22MT-N	FLEXFRAME-SS	PAVER-CP-MT	PAVER-VENT-4LNLS	FG-LAVA-10 (x3)	OAS-LPK41
FPB-29D22MTN-PK	29" to 32"	FPB-29DBS22MT-N	FLEXFRAME-SS3	PAVER-CP-MT	PAVER-VENT-4LNLS	FG-LAVA-40	OAS-LPK31
FPB-34D31MTN-PK	34" to 37"	FPB-34DBS31MT-N	FLEXFRAME-SS3	PAVER-CP-MT	PAVER-VENT-4LNLS	FG-LAVA-40 + FG-LAVA-10	OAS-LPK26
FPB-34D31MTN-PK2	34" to 37"	FPB-34DBS31MT-N	FLEXFRAME-SS3	PAVER-CP-MT	PAVER-VENT-6LNLS	FG-LAVA-40 + FG-LAVA-10	OAS-LPK26
FPB-39DBS36MTN-PK	39" to 42"	FPB-39DBS36MT-N	FLEXFRAME-SS3	PAVER-CP-MT	PAVER-VENT-4LNLS	FG-LAVA-40 + FG-LAVA-10	OAS-LPK12
FPB-44DBS36MTN-PK	44" to 47"	FPB-44DBS36MT-N	FLEXFRAME-SS3	PAVER-CP-MT	PAVER-VENT-4LNLS	FG-LAVA-40 + FG-LAVA-10 (x2)	OAS-LPK12

Square — Flat

MT

Model	Fits Inside Diameter	Burner System	Flexframe	Control Panel	Vent Kit	Media	LP Conv.
FPB-25SF22MTN-PK	25" to 28"	FPB-25SFBS22MT-N	FLEXFRAME-SS	PAVER-CP-MT	PAVER-VENT-4LNLS	FG-LAVA-10 (x3)	OAS-LPK31
FPB-30SF22MTN-PK	30" to 33"	FPB-30SFBS22MT-N	FLEXFRAME-SS3	PAVER-CP-MT	PAVER-VENT-4LNLS	FG-LAVA-40	OAS-LPK31
FPB-34SF31MTN-PK	34" to 37"	FPB-34SFBS31MT-N	FLEXFRAME-SS3	PAVER-CP-MT	PAVER-VENT-4LNLS	FG-LAVA-40 + FG-LAVA-10	OAS-LPK26
FPB-40SFS36MT-PK2	40" to 43"	FPB-40SFB36MT-N	FLEXFRAME-SS3	PAVER-CP-MT	PAVER-VENT-4LNLS	FG-LAVA-40 + FG-LAVA-10	OAS-LPK12
FPB-40SFS36MTN-PK	40" to 43"	FPB-40SFB36MT-N	FLEXFRAME-SS3	PAVER-CP-MT	PAVER-VENT-6LNLS	FG-LAVA-40 + FG-LAVA-10	OAS-LPK12

Square — Drop-In

MT

Model	Fits Inside Diameter	Burner System	Flexframe	Control Panel	Vent Kit	Media	LP Conv.
FPB-20SBS16MTN-PK	20" to 23"	FPB-20SBS16MT-N	FLEXFRAME-SS	PAVER-CP-MT	PAVER-VENT-4LNLS	FG-LAVA-10 (x2)	OAS-LPK31

Linear — Flat

MT

Model	Fits Inside Diameter	Burner System	Flexframe	Control Panel	Vent Kit	Media	LP Conv.
LOF-3014FHMTN-PK	30" to 33" L, x 14" to 17" W	LOF-3014FHMT-N	FLEXFRAME-SS	PAVER-CP-MT	PAVER-VENT-4LNLS	FG-LAVA-40	OAS-LPK12
LOF-3614FHMTN-PK	36" to 40" L, 14" to 18" W	LOF-3614FHMT-N	FLEXFRAME-SS3	PAVER-CP-MT	PAVER-VENT-4LNLS	FG-LAVA-40 + FG-LAVA-10	OAS-LPK31
LOF-4814FHMTN-PK	48" to 52" L, 14" to 18" W	LOF-4814FHMT-N	FLEXFRAME-SS3	PAVER-CP-MT	PAVER-VENT-4LNLS	FG-LAVA-40 + FG-LAVA-10 (x3)	OAS-LPK29
LOF-6016FHMTN-PK	60" to 64" L, 16" to 20" W	LOF-6016FHMT-N	FLEXFRAME-SS3	PAVER-CP-MT	PAVER-VENT-4LNLS	FG-LAVA-40 + FG-LAVA-10 (x2)	OAS-LPK26

Pro Series SRW/Paver Kits

One model number - each package provides the all-in-one solution for upgrading to a gas fire pit.

All models are sold in either Natural Gas or Liquid Propane from the factory.

To the right you will find a representation of what's in the box of each package.



BURNER SYSTEM



FLEX FRAME



CONTROL PANEL



VENT KIT



MEDIA



○ Round — Flat

MT

Model	Fits Inside Diameter	Burner System	Flexframe	Control Panel	Vent Kit	Media	Gas Type
FPB-26DPS21MTN-PK	26" to 29"	FPB-26DPSBR21MT-N	FLEXFRAME-SS	PAVER-CP-MT	PAVER-VENT-4LNLS	FG-LAVA-10 (x3)	NG
FPB-29DPS21MTN-PK	29" to 33"	FPB-29DPSBR21MT-N	FLEXFRAME-SS3	PAVER-CP-MT	PAVER-VENT-4LNLS	FG-LAVA-40	NG
FPB-34DPS21MTN-PK	34" to 39"	FPB-34DPSBR21MT-N	FLEXFRAME-SS3	PAVER-CP-MT	PAVER-VENT-4LNLS	FG-LAVA-40 + FG-LAVA-10	NG
FPB-34DPS21MTN-PK6	34" to 39"	FPB-34DPSBR21MT-N	FLEXFRAME-SS3	PAVER-CP-MT	PAVER-VENT-6LNLS	FG-LAVA-40 + FG-LAVA-10	NG
FPB-26DPS21MTP-PK	26" to 29"	FPB-26DPSBR21MT-P	FLEXFRAME-SS	PAVER-CP-MT	PAVER-VENT-4LNLS	FG-LAVA-10 (x3)	LP
FPB-29DPS21MTP-PK	29" to 33"	FPB-29DPSBR21MT-P	FLEXFRAME-SS3	PAVER-CP-MT	PAVER-VENT-4LNLS	FG-LAVA-40	LP
FPB-34DPS21MTP-PK	34" to 39"	FPB-34DPSBR21MT-P	FLEXFRAME-SS3	PAVER-CP-MT	PAVER-VENT-4LNLS	FG-LAVA-40 + FG-LAVA-10	LP
FPB-34DPS21MTP-PK6	34" to 39"	FPB-34DPSBR21MT-P	FLEXFRAME-SS3	PAVER-CP-MT	PAVER-VENT-6LNLS	FG-LAVA-40 + FG-LAVA-10	LP

□ Square — Flat

MT

Model	Fits Inside Diameter	Burner System	Flexframe	Control Panel	Vent Kit	Media	Gas Type
FPB-25-SFPS21MTN-PK	25" to 30"	FPB-25SFPSBR21MT-N	FLEXFRAME-SS	PAVER-CP-MT	PAVER-VENT-4LNLS	FG-LAVA-10 (x3)	NG
FPB-30SFPS21MTN-PK	30" to 35"	FPB-30SFPSBR21MT-N	FLEXFRAME-SS3	PAVER-CP-MT	PAVER-VENT-4LNLS	FG-LAVA-40	NG
FPB-34-SFPS21MTN-PK	34" to 39"	FPB-34SFPSBR21MT-N	FLEXFRAME-SS3	PAVER-CP-MT	PAVER-VENT-4LNLS	FG-LAVA-40 + FG-LAVA-10	NG
FPB-25-SFPS21MTP-PK	25" to 30"	FPB-25SFPSBR21MT-P	FLEXFRAME-SS	PAVER-CP-MT	PAVER-VENT-4LNLS	FG-LAVA-10 (x3)	LP
FPB-30SFPS21MTP-PK	30" to 35"	FPB-30SFPSBR21MT-P	FLEXFRAME-SS3	PAVER-CP-MT	PAVER-VENT-4LNLS	FG-LAVA-40	LP
FPB-34-SFPS21MTP-PK	34" to 39"	FPB-34SFPSBR21MT-P	FLEXFRAME-SS3	PAVER-CP-MT	PAVER-VENT-4LNLS	FG-LAVA-40 + FG-LAVA-10	LP

□ Square — Drop-In

MT

Model	Fits Inside Diameter	Burner System	Flexframe	Control Panel	Vent Kit	Media	Gas Type
FPB-20SPS14MTN-PK	20" to 25"	FPB-20SPSBR14MT-N	FLEXFRAME-SS	PAVER-CP-MT	PAVER-VENT-4LNLS	FG-LAVA-10 (x2)	NG
FPB-20SPS14MTP-PK	20" to 25"	FPB-20SPSBR14MT-P	FLEXFRAME-SS	PAVER-CP-MT	PAVER-VENT-4LNLS	FG-LAVA-10 (x2)	LP

□ Linear — Flat

MT

Model	Fits Inside Diameter	Burner System	Flexframe	Control Panel	Vent Kit	Media	Gas Type
LOF-3010PS246MTN-PK	30" to 35" L, 10" to 15" W	LOF-3010PS246MT-N	FLEXFRAME-SS	PAVER-CP-MT	PAVER-VENT-4LNLS	FG-LAVA-10 (x3)	NG
LOF-3610PS306MTN-PK	36" to 41" L, 10" to 15" W	LOF-3610PS306MT-N	FLEXFRAME-SS3	PAVER-CP-MT	PAVER-VENT-4LNLS	FG-LAVA-40	NG
LOF-4810PS406MTN-PK	48" to 53" L, 10" to 15" W	LOF-4810PS406MT-N	FLEXFRAME-SS3	PAVER-CP-MT	PAVER-VENT-4LNLS	FG-LAVA-40 + FG-LAVA-10	NG
LOF-6010PS506MTN-PK	60" to 65" L, 10" to 15" W	LOF-6010PS506MT-N	FLEXFRAME-SS3	PAVER-CP-MT	PAVER-VENT-4LNLS	FG-LAVA-40 + FG-LAVA-10 (x2)	NG
LOF-3010PS246MTP-PK	30" to 35" L, 10" to 15" W	LOF-3010PS246MT-P	FLEXFRAME-SS	PAVER-CP-MT	PAVER-VENT-4LNLS	FG-LAVA-10 (x3)	LP
LOF-3610PS306MTP-PK	36" to 41" L, 10" to 15" W	LOF-3610PS306MT-P	FLEXFRAME-SS3	PAVER-CP-MT	PAVER-VENT-4LNLS	FG-LAVA-40	LP
LOF-4810PS406MTP-PK	48" to 53" L, 10" to 15" W	LOF-4810PS406MT-P	FLEXFRAME-SS3	PAVER-CP-MT	PAVER-VENT-4LNLS	FG-LAVA-40 + FG-LAVA-10	LP
LOF-6010PS506MTP-PK	60" to 65" L, 10" to 15" W	LOF-6010PS506MT-P	FLEXFRAME-SS3	PAVER-CP-MT	PAVER-VENT-4LNLS	FG-LAVA-40 + FG-LAVA-10 (x2)	LP

SRW/Paver FPB Accessories

Flexframe

COMPATIBLE WITH



Made in the USA

Allows you the flexibility to fill the gap between the fire pit structure and the pan.

Allows you to easily remove the burner without disturbing the structure.

Flexible and easy to adapt for round, square, and rectangular fire pits.

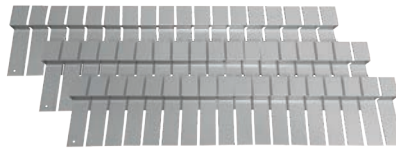

FLEXFRAME-PRO3

Wider version of the flexframe. Comes as a three piece kit. This larger size allows the use of any round, square or linear drop-in pan or flat in fire pits up to 6" larger than their OD size.

Three (3) 44" pieces per package.



Flexframe-SS

Two (2) 44" pieces per package. Allows up to 3" span into fire pit.

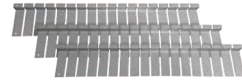

Flexframe-SS3

Three (3) 44" pieces per package. Allows up to 3" span into fire pit.

SRW / Paver Control Panels

Made in the USA

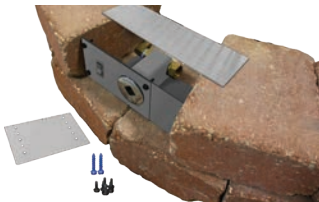

PAVER-CP-AWS

For use when building fire pit enclosures with SRW block and an AWS burner system.

INCLUDES:

SRW bracket kit and extender
Lintel - 12" L x 3" W
Screws and fittings
Tapcon® concrete anchors

COMPATIBLE WITH

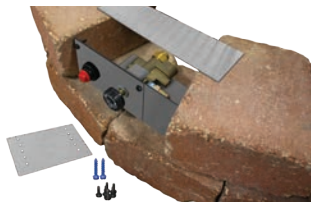

PAVER-CP-TPSI

For use when building fire pit enclosures with SRW block and an TPSI burner system.

INCLUDES:

SRW bracket kit and extender
Lintel - 12" L x 3" W
Screws and fittings
Tapcon® concrete anchors

COMPATIBLE WITH

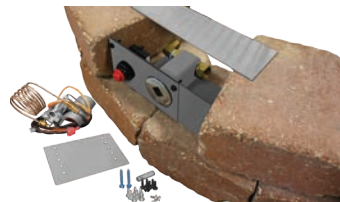

PAVER-CP-MT-MSI

For use when building fire pit enclosures with SRW block and an MT burner system.

INCLUDES:

Face plate for key valve and MSI
SRW bracket kit and extender
Lintel - 12" L x 3" W
Battery operated Piezo igniter
Ignition hood
Screws and fittings
Tapcon® concrete anchors

COMPATIBLE WITH



PAVER-CP-MT

For use when building fire pit enclosures with SRW block and an MT burner system.

INCLUDES:

SRW bracket kit and extender
Lintel - 12" L x 3" W
Screws and fittings
Tapcon® concrete anchors

COMPATIBLE WITH



SRW / Paver Vent Kits

Made in the USA



PAVER-VENT-4-LNTS

Stainless steel SRW vent kit with lintel. Each vent provides 18 square inches of ventilation.

INCLUDES:

Two (2) 3 5/8" H x 8" W vents with mounting plate, extension plate extends overall size up to 10" W
Two (2) Tapcon® concrete anchors
Two (2) Lintels 12" L x 3" W (20 gauge galvanized steel)

COMPATIBLE WITH

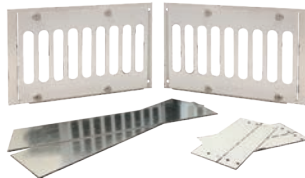

PAVER-VENT-6-LNTS

Stainless steel SRW vent kit with lintel. Each vent provides 18 square inches of ventilation.

INCLUDES:

Two (2) 5 5/8" H x 8" W vents with mounting plate, extension plate extends overall size up to 10" W
Two (2) Tapcon® concrete anchors
Two (2) Lintels 12" L x 3" W (20 gauge galvanized steel)

COMPATIBLE WITH



MSI-BSMTI

Manual spark ignition kit for FPB "MT" Match Throw Systems featuring the burning spur.

COMPATIBLE WITH





Linear RTF

Model	Description
RTF-L10824	108" L x 24" W x 18" T
RTF-L10834	108" L x 34" W x 18" T
RTF-L4224	42" L x 24" W x 18" T
RTF-L4234	42" L x 34" W x 18" T
RTF-L6024	60" L x 24" W x 18" T
RTF-L6034	60" L x 34" W x 18" T
RTF-L8424	84" L x 24" W x 18" T
RTF-L8434	84" L x 34" W x 18" T



Round RTF

Model	Description
RTF-R42	42" Diameter x 18" T
RTF-R48	48" Diameter x 18" T
RTF-R60	60" Diameter x 18" T

Features

The exterior panels are factory clad with 1/2" Permaplex cement board. Permaplex is impact resistant, extremely durable and dimensionally stable. It has overall flexural, compressive and tensile strength characteristics, highly moisture resistant and will not rot, disintegrate or swell when exposed to water.



Square RTF

Model	Description
RTF-S42	42" W x 42" W x 18" T
RTF-S48	48" W x 48" W x 18" T
RTF-S60	60" W x 60" W x 18" T

Supports up to 700lbs.

Template lines on top of units for easy cut outs.

Warranty: Lifetime warranty on construction and manufacturer defects.

Comes included with a VENT-KIT-6X12

Rock Media



Lava Rock

Each rock is approximately 1" to 2" in diameter

FG-LAVA-10 10 lbs.

FG-LAVA-40 1 cubic foot (approx 30 - 40 lbs.)



Lava Stones

Each stone is approximately 1" to 2" in diameter

FG-LS50 50 lbs.

Broken Glass

APPROXIMATELY 1/2" TO 1" IN SIZE

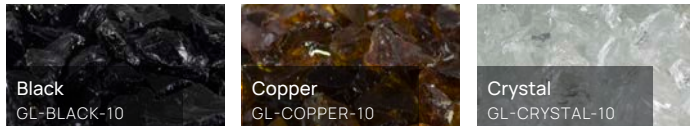

Reflective Glass

APPROXIMATELY 1/2" TO 1" IN SIZE

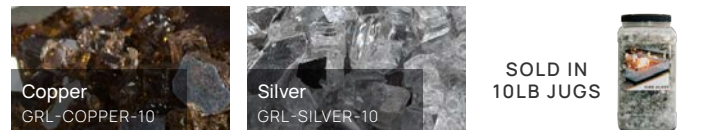
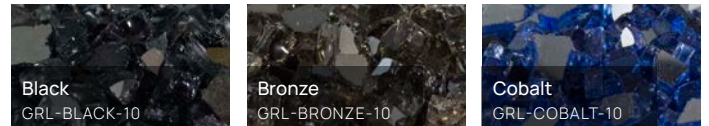

Steel Log Sets

PRO SERIES



Steel Twig Sets

PRO SERIES



Log Sets

REFRACTORY CONCRETE

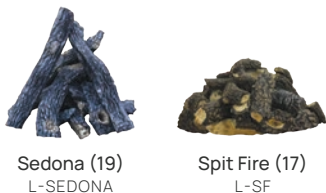

Twig Sets

REFRACTORY CONCRETE





Accessories

Glass Windshields

ALL WINDSHIELDS ARE 1/4" THICK (5MM)

Round Windshields

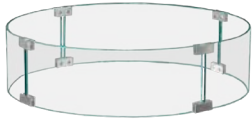

Model	Dimensions
GWS-23R	23" Diameter x 8" H
GWS-32R	32" Diameter x 8" H
GWS-36R	36" Diameter x 8" H
GWS-38R	38" Diameter x 8" H
GWS-48R	48" Diameter x 8" H
GWS-60R	60" Diameter x 8" H

Square Windshields



Model	Dimensions
GWS-2424	24" W x 7 1/2" H
GWS-3030	30" W x 7 1/2" H
GWS-3838	38" W x 7 1/2" H
GWS-4242	42" W x 7 1/2" H

Linear Windshields

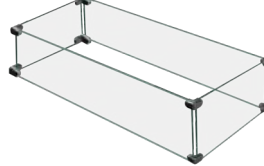

Model	Dimensions
GWS-2911	29 1/2" L x 11 1/2" W x 6" H
GWS-2917	29 1/2" L x 17" W x 6" H
GWS-3511	35 1/2" L x 11 1/2" W x 6" H
GWS-3517	35 1/2" L x 17" W x 6" H
GWS-4111	41 1/2" L x 11 1/2" W x 6" H
GWS-4119	41" L x 19" W x 6" H

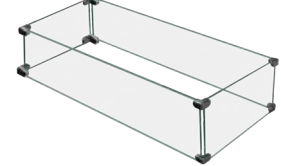

Model	Dimensions
GWS-5311	53 1/2" L x 11 1/2" W x 6" H
GWS-5319	53" L x 19" W x 6" H
GWS-6511	65 1/2" L x 11 1/2" W x 6" H
GWS-6521	65" L x 21" W x 6" H
GWS-7711	77 1/2" L x 11 1/2" W x 6" H
GWS-7721	77" L x 21" W x 6" H

Stainless Steel Lids

ALL LIDS ARE CONSTRUCTED OF STAINLESS STEEL | *HEIGHT INCLUDES HANDLE



Round Lids



Model	Dimensions	Fits Models
LID-19R2	22" Diameter x 2.5" H	FPB-19R Series
LID-25R2	28" Diameter x 2.5" H	FPB-25R Series
LID-29R2	32" Diameter x 2.5" H	FPB-29R Series
LID-33R2	36" Diameter x 2.5" H	FPB-33R Series

Square Lids

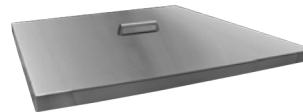

Model	Dimensions	Fits Models
LID-20S	22 1/4" W x 2" H	FPB-20S Series
LID-26S	28 1/4" W x 2" H	FPB-26S Series
LID-32S	34 1/4" W x 2" H	FPB-32S Series
LID-38S	40 1/4" W x 2" H	FPB-38S Series

Linear Lids for H Burners

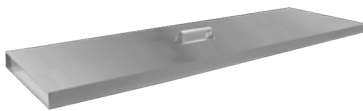

Model	Dimensions	Fits Models
LID-LOF2412	26 3/4" L x 14 3/4" W x 2 7/8" H	LOF2412
LID-LOF3012	32 3/4" L x 14 3/4" W x 2 7/8" H	LOF3012
LID-LOF3614	38 3/4" L x 16 3/4" W x 2 7/8" H	LOF3614
LID-LOF4214	44 3/4" L x 16 3/4" W x 2 7/8" H	LOF4214
LID-LOF4814	50 3/4" L x 16 3/4" W x 2 7/8" H	LOF4814
LID-LOF6016	62 3/4" L x 18 3/4" W x 2 7/8" H	LOF6016
LID-LOF7216	74 3/4" L x 18 3/4" W x 2 7/8" H	LOF7216
LID-LOF8416	86 3/4" L x 18 3/4" W x 2 7/8" H	LOF8416
LID-LOF9616	98 3/4" L x 18 3/4" W x 2 7/8" H	LOF9616

Linear Lids for T Burners

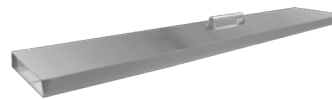

Model	Dimensions	Fits Models
LID-LOF2406	26 3/4" L x 8 3/4" W x 2 7/8" H	LOF2406
LID-LOF3006	32 3/4" L x 8 3/4" W x 2 7/8" H	LOF3006
LID-LOF3606	38 3/4" L x 8 3/4" W x 2 7/8" H	LOF3606
LID-LOF4806	50 3/4" L x 8 3/4" W x 2 7/8" H	LOF4806
LID-LOF6006	62 3/4" L x 8 3/4" W x 2 7/8" H	LOF6006
LID-LOF7206	74 3/4" L x 8 3/4" W x 2 7/8" H	LOF7206
LID-LOF8406	86 3/4" L x 8 3/4" W x 2 7/8" H	LOF8406
LID-LOF9606	98 3/4" L x 8 3/4" W x 2 7/8" H	LOF9606

Gas Valves / Gas Valve Accessories / Vent Kit



KEY-PC-12
12" polished chrome key for key valve



KV-PC-12
High capacity straight key valve with polished chrome key cover and 12" key (350,000 BTU @ 1/2 PSI)



MSI-BSMTI
Manual spark ignition kit for FPB "MT" Match Throw Systems featuring the burning spur.



VENT-KIT-6X12SS
Includes 2 stainless steel 6" tall x 12" wide vents. Each vent provides 18 square inches of cross ventilation.

Estop Timers & Accessories



ESTOP1-0H

- Unique all mechanical gas shut-off timer with built-in emergency stop - no power required
- High Btu capacity
- Safest gas timer available in the industry
- Available in 1 hour models
- Innovative multi-port design provides installation flexibility
- 1/2" NPT inlets and outlets (side and back)
- Six (6) mounting holes (front and side) for secure installation
- Natural gas (NG) or Liquid Propane (LP) - no conversion necessary
- Dial has UV Protection



ESTOP-CP-KIT
Control panel designed to house ESTOP1-0H timer.



ESTOP-LC-KIT
Locking Cabinet designed to house ESTOP1-0H timer (Removable Lock)



ESTOP-RM-KIT
Surface mount enclosure designed to house ESTOP1-0H timer.

Propane Accessories



FG-12QDK
Quick Disconnect Kit for use with Natural Gas or Liquid Propane - 12' (144"), 3/8" I.D.



FG-32LPHRK
32" Liquid Propane Hose and Regulator Kit, Rated at 85,375 BTU @10" W.C. CSA-AGA/CGA Approved.



FG-60LPHRK
60" Liquid Propane Hose and Regulator Kit, Rated at 130K BTU @10" W.C. CSA-AGA/CGA Approved.



FG-LPQDK
LP quick disconnect kit - includes 12' (144") 1/2" OD, 3/8" ID, gray PVC hose with quick disconnect fitting.



FG-LPRK
100K BTU Liquid Propane Regulator, 3/8" MPT Adapter and Acme Quick Connect. CSA-AGA/CGA approved.



Fire Feature Accessories

Gas Flex



T200-9898-10

1/2" OD (3/8" ID) x 10", with 1/2" OD FLARE NUTS

T200-9898-16

1/2" OD (3/8" ID) x 16", with 1/2" OD FLARE NUTS

T200-9898-22

1/2" OD (3/8" ID) x 22", with 1/2" OD FLARE NUTS

T200-9898-28

1/2" OD (3/8" ID) x 28", with 1/2" OD FLARE NUTS

T200-9898-34

1/2" OD (3/8" ID) x 34", with 1/2" OD FLARE NUTS

T200-9898-46

1/2" OD (3/8" ID) x 46", with 1/2" OD FLARE NUTS

Gas Fittings



U1-6C-S

Steel Gas Flare Fitting,
3/8" OD Flare x 3/8" MIP
(tapped 1/8" FIP)



U1-6D-S

Steel Gas Flare Fitting,
3/8" OD Flare x 1/2" MIP
(tapped 3/8" FIP)



U1-8C-S

Steel Gas Flare Fitting,
1/2" OD Flare x 3/8" MIP
(tapped 1/4" FIP)



U1-8D-S

Steel Gas Flare Fitting,
1/2" OD Flare x 1/2" MIP
(tapped 3/8" FIP)



U3-6D-S

Steel Gas Flare Fitting,
3/8" OD Flare x 1/2" FIP



U3-8D-S

Steel Gas Flare Fitting,
1/2" OD Flare x 1/2" FIP

Conversion Kits

Model	Ignition	BTU	Description
FG-AWS-PBO-P	AWS	N/A	Pilot Burner Orifice for FG-AWS30VDC-GOEK and FG-AWS30VDC-K (AWEIS Standard Capacity 30VDC Valve)
OAS-LPK12	MT	250,000	Universal LP Conversion kit for: 250,000 BTU, includes: OAS-LP12, #S499-8, #113-SS4-D5, U3-8D-S
OAS-LPK19	MT	225,000	Universal LP Conversion kit for: 225,000 BTU, includes: OAS-LP19, #S499-8, #113-SS4-D5, U3-8D-S
OAS-LPK22	MT	200,000	Universal LP Conversion kit for: 200,000 BTU, includes: OAS-LP22, #S499-8, #113-SS4-D5, U3-8D-S
OAS-LPK26	MT	175,000	Universal LP Conversion kit for: 175,000 BTU, includes: OAS-LP29, #S499-8, #113-SS4-D5, U3-8D-S
OAS-LPK29	MT	150,000	Universal LP Conversion kit for: 150,000 BTU, includes: OAS-LP29, #S499-8, #113-SS4-D5, U3-8D-S
OAS-LPK31	MT	125,000	Universal LP Conversion kit for: 125,000 BTU, includes: OAS-LP31, #S499-8, #113-SS4-D5, U3-8D-S
OAS-LPK35	MT	100,000	Universal LP Conversion kit for: 100,000 BTU, includes: OAS-LP35, #S499-8, #113-SS4-D5, U3-8D-S
OAS-LPK41	MT	75,000	Universal LP Conversion kit for: 75,000 BTU, includes: OAS-LP41, #S499-8, #113-SS4-D5, U3-8D-S
OAS-LPK47	MT	50,000	Universal LP Conversion kit for: 50,000 BTU, includes: OAS-LP47, #S499-8, #113-SS4-D5, U3-8D-S
TPSI-LPK29	TPSI	150,000	TPSI LP Conversion kit for: 150,000 BTU, includes: Main Burner Orifice OAS-LP29, PSE-SUB163 (Pilot Orifice)
TPSI-LPK31	TPSI	125,000	TPSI LP Conversion kit for: 125,000 BTU, includes: Main Burner Orifice OAS-LP31, PSE-SUB163 (Pilot Orifice)
TPSI-LPK35	TPSI	100,000	TPSI LP Conversion kit for: 100,000 BTU, includes: Main Burner Orifice OAS-LP35, PSE-SUB163 (Pilot Orifice)
TPSI-LPK41	TPSI	75,000	TPSI LP Conversion kit for: 75,000 BTU, includes: Main Burner Orifice OAS-LP41, PSE-SUB163 (Pilot Orifice)
TPSI-LPK47	TPSI	50,000	TPSI LP Conversion kit for: 50,000 BTU, includes: Main Burner Orifice OAS-LP47, PSE-SUB163 (Pilot Orifice)
OFF-36LECO-LPK	Kalea Bay	N/A	36" Kalea Bay - LP Conversion kit for use with models: OFF-36LECO-N and OFF-36LECO-NLED
OFF-48LECO-LPK	Kalea Bay	N/A	48" Kalea Bay - LP Conversion kit for use with models: OFF-48LECO-N and OFF-48LECO-NLED
OFF-60LECO-LPK	Kalea Bay	N/A	60" Kalea Bay - LP Conversion kit for use with models: OFF-60LECO-N and OFF-60LECO-NLED
OFF-72LECO-LPK	Kalea Bay	N/A	72" Kalea Bay - LP Conversion kit for use with models: OFF-72LECO-N and OFF-72LECO-NLED

Replacement Parts & Kits

FG-AWS-SVC-KIT

- FG-TP : Thermopile - for primary pilot assembly
- FG-HSI : Hot Surface Ignition - for pilot burner assembly
- FG-AWS-CONTROLLER : Main Controller Module

FG-TMSI-PILOT-SVC-KIT

- FG-IGNIT-ASSSY-PI: Igniter Assembly
- FG-SPARK-IGN: Spark Igniter Assembly
- FG-GASVALVE-2: Gas Valve (piloted)
- FG-CONTROL-KNOB: Control Knob

FG-TFS-SVC-KIT

- VCS-5000MODTC : Module
- AF-4000BP12 : Battery Pack w/12' wire
- TFS-IGNT-ASSEMBLY : Igniter Assembly
- ST3-100-1027 : Mesh Screen cover for Ignition Hood
- ST3-113-1028 : Stainless Thread Cutting Screws (8)

FG-LTFS-SVC-KIT

- PILOTO23300-206 : Pilot Assembly
- VCS-5000MODTC : Module
- AF-4000BP12 : Battery Pack w/12' wire

FG-TMSI-SVC-KIT

- TMS-TC-ASSEMBLY : Thermocouple/Rainshield Replacement Kit
- ST3-080-1009 : Copreci Manual Gas Valve
- ST3-110-1005: Mounting Nut for Copreci Valve
- ST3-050-1024 : Manual Gas Valve Knob for Copreci Valve
- 3042-RB : Manual Spark Ignitor Module with Red Button
- PIEZO23WH : 23" Piezo Extension wire
- PIEZO48WH : 48" Piezo Extension wire
- ST3-100-1027 : Mesh Screen Cover (for ignition hood)
- ST3-113-1028 : Stainless Thread Cutting Screws



PILOTO-23300-206
L series burner pilot assembly



FG-SPARK-IGN
Spark igniter for TMSI LOF systems



FG-CONTROL-KNOB
Control knob for all LOF burners featuring TMSI LOF ignition



VCS-5000MODTC
Ignition module



FG-THERMOCOUPLE
Thermocouple for non-piloted TMSI Line Of Fire systems



ST3-080-1009
Copreci manual gas valve for round, square and flat burners featuring TMSI ignition system



FG-IGNIT-ASSY-PI
Ignition assembly for piloted TMSI Line Of Fire systems



FG-GASVALVE-2
Gas Valve (piloted) Fits: LOF-48LHTMSI-N, LOF-48LTTMSI-N, LOF-60LTTMSI-N



TMSI-TC-ASSEMBLY
Copreci Thermocouple with Ignition hood



FG-GASVALVE-1
Gas valve (non-piloted) for LOF TMSI systems



TFS-IGNT-ASSEMBLY
Ignition module, igniter probes, thermocouple and ignition hood

AWS Ignition Accessories & Replacement Parts

POOL CERTIFIED



FG-AWS-PS-30V320
30VDC, 320W Power Supply



GOE-30VDC
30 VDC power supply for single fire feature



AWS-SWITCH-KIT
Stainless steel faceplate with switch



AWS-FACEPLATE
Stainless steel faceplate (only)



FG-PBA
AWS pilot burner assembly (30" long)



FG-AWS-PBO-P
Pilot burner orifice for FG-AWS30VDC-GOEK and FG-AWS30VDC-K.



FG-TIMER-2HR
Two (2) hour mechanical timer.



FG-1420-AOD
1420-A (On/Off/Remote) with 110 Receiver.



FG-EMER-STOP
Electronic emergency stop for 120VAC or 30 VDC.



FG-FD2HW
120 min mechanical timer (no enclosure)



FG-ICB
AWS Ignition control box



FG-HEATSHIELD
AWS heat shield

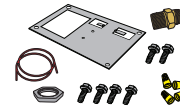

FG-AWS-HARDWARE-BAG
Hardware bag for AWS valve systems

Built for NG. If LP is required, must purchase FG-AWS-PBO-P

Primary Pilot Orifice is only orifice need for LP conversion of FG-PBA pilot assembly



How Much Media Should I Use?

Kalea Bay

Model	Glass Only
36" Kalea Bay	15 lbs
48" Kalea Bay	20 lbs
60" Kalea Bay	25 lbs
72" Kalea Bay	25 lbs

Sanctuary 1

Glass Only	Lava Rock	Lava Stones
30 lbs	20 lbs	35 lbs

Sanctuary 2/3

Model	Glass Only	Lava Rock Is a Base	Lava Stones on Top of Lava Rock
Sanct 2	120 lbs	30 lbs	30 lbs
Sanct 3	70 lbs	15 lbs	20 lbs

Round Fire Pits

Inside Diameter of Fire Pit	Lava Rock Only	Lava Rock as a Base	Glass on Top of Lava Rock	Lava Stones on Top of Lava Rock	Glass Only
16"	10 lbs	5 lbs	10 lbs	10 lbs	30 lbs
19"	10 lbs	10 lbs	20 lbs	15 lbs	40 lbs
25"	15 lbs	15 lbs	30 lbs	20 lbs	70 lbs
29"	20 lbs	20 lbs	40 lbs	25 lbs	90 lbs
33"	25 lbs	25 lbs	50 lbs	30 lbs	110 lbs
34"	30 lbs	25 lbs	60 lbs	30 lbs	120 lbs
44"	45 lbs	35 lbs	70 lbs	50 lbs	200 lbs

Square Fire Pits

Inside Diameter of Fire Pit	Lava Rock Only	Lava Rock as a Base	Glass on Top of Lava Rock	Lava Stones on Top of Lava Rock	Glass Only
20"	10 lbs	10 lbs	20 lbs	15 lbs	50 lbs
26"	15 lbs	15 lbs	30 lbs	20 lbs	90 lbs
32"	25 lbs	25 lbs	50 lbs	30 lbs	130 lbs
38"	30 lbs	30 lbs	60 lbs	35 lbs	190 lbs

Pro LOF - H Flat

AWS / TPSI / MT	Lava Rock Only	Glass Only	Lava Stones Only
LOF-3010PS246	20 lbs	40 lbs	20 lbs
LOF-3610PS306	20 lbs	50 lbs	20 lbs
LOF-4810PS406	30 lbs	60 lbs	30 lbs
LOF-6010PS506	40 lbs	80 lbs	40 lbs
LOF-7210PS606	50 lbs	100 lbs	50 lbs
LOF-9610PS806	60 lbs	130 lbs	60 lbs

H Drop-In

AWS / TPSI / MT	Lava Rock Only	Glass Only	Lava Stones Only
LOF-2412H	20 lbs	40 lbs	20 lbs
LOF-3012H	20 lbs	50 lbs	20 lbs
LOF-3614H	30 lbs	70 lbs	30 lbs
LOF-4814H	40 lbs	90 lbs	40 lbs
LOF-6016H	50 lbs	130 lbs	50 lbs
LOF-7216H	60 lbs	150 lbs	60 lbs
LOF-8416H	70 lbs	180 lbs	70 lbs
LOF-9616H	80 lbs	200 lbs	80 lbs

H Flat

AWS / TPSI / MT	Lava Rock Only	Glass Only	Lava Stones Only
LOF-2414FH	20 lbs	50 lbs	20 lbs
LOF-3014FH	20 lbs	60 lbs	20 lbs
LOF-3614FH	30 lbs	70 lbs	30 lbs
LOF-4814FH	40 lbs	90 lbs	40 lbs
LOF-6016FH	50 lbs	130 lbs	50 lbs
LOF-7216FH	60 lbs	150 lbs	60 lbs
LOF-8416FH	70 lbs	180 lbs	70 lbs
LOF-9616FH	80 lbs	200 lbs	80 lbs

T Drop-In

AWS / TPSI / MT	Lava Rock Only	Glass Only	Lava Stones Only
LOF-2406T	10 lbs	20 lbs	10 lbs
LOF-3006T	10 lbs	30 lbs	10 lbs
LOF-3606T	10 lbs	30 lbs	10 lbs
LOF-4806T	20 lbs	40 lbs	20 lbs
LOF-6006T	20 lbs	50 lbs	20 lbs
LOF-7206T	20 lbs	60 lbs	20 lbs
LOF-8406T	30 lbs	70 lbs	30 lbs
LOF-9606T	30 lbs	80 lbs	30 lbs

T Flat

AWS / TPSI / MT	Lava Rock Only	Glass Only	Lava Stones Only
LOF-2408FT	10 lbs	30 lbs	10 lbs
LOF-3008FT	20 lbs	30 lbs	20 lbs
LOF-3608FT	20 lbs	40 lbs	20 lbs
LOF-4808FT	20 lbs	50 lbs	20 lbs
LOF-6008FT	30 lbs	60 lbs	30 lbs
LOF-7208FT	30 lbs	80 lbs	30 lbs
LOF-8408FT	40 lbs	90 lbs	40 lbs
LOF-9608FT	40 lbs	100 lbs	40 lbs

Lava Rock & Glass

In order to use glass, you must lay down a layer of lava rock. Fill the pan with lava rock until it is level with the top of the burner. Then take your glass and lay it on top of the lava rock and burner. The glass should only be 3/4" to 1" thick, or just enough to cover the burner.

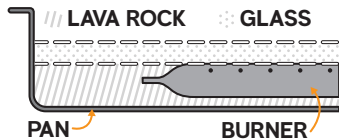

Lava Rock Only

When using lava rock, use enough to cover entire burner. Do not over-fill. Just use enough to hide the burner from view.

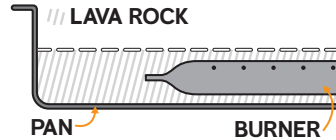

Lava Rock & Stones

In order to use lava stones, you must lay down a layer of lava rock. Fill the pan with lava rock until it is level with the top of the burner. Then take your lava stones and lay it on top of the lava rock and burner. The lava stones should only be one layer thick, just enough to cover the burner.

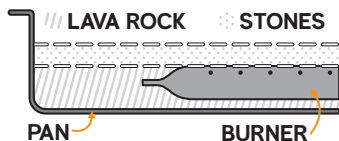



Gas Pipe Sizing Chart

Natural Gas

Pipe Length (feet)	1/2"	3/4"	1"	1 - 1/4"	1 - 1/2"	2"	2 - 2 1/2"	3"	4"
10	108	230	387	793	1237	2259	3640	6434	-
20	75	160	280	569	877	1610	2613	5236	9521
30	61	129	224	471	719	1335	2165	4107	7859
40	52	110	196	401	635	1143	1867	3258	6795
50	46	98	177	364	560	1041	1680	2936	6142
60	42	89	159	336	513	957	1559	2684	5647
70	38	82	149	317	476	896	1447	2492	5250
80	36	76	140	239	443	840	1353	2315	4900
90	33	71	133	275	420	793	1288	2203	4667
100	32	68	126	266	411	775	1246	2128	4518
125	28	60	117	243	369	700	1143	1904	4065
150	25	54	105	215	327	625	1008	1689	3645
175	23	50	93	196	303	583	993	1554	3370
200	22	47	84	182	280	541	877	1437	3160
300	17	37	70	145	224	439	686	1139	2539

Natural Gas (NG) flow is given in thousands of BTU/hr. One cubic foot of NG gas - 1000 BTU.

Nominal pressure at the burner for Natural Gas is 3.5" of water column. (Typical machine supply 5" - 7").

Pipe length must include additional length for all fittings. Add approximately 5 feet of pipe per fitting.

Natural Gas Example: A machine with a burner that requires 440,000 BTU would need a 1 - 1/4" pipe for a 20' long run.

Liquid Propane

Pipe Length (feet)	1/2"	3/4"	1"	1 - 1/4"	1 - 1/2"	2"	2 - 2 1/2"	3"	4"
10	275	567	1071	2205	3307	6221	10140	17990	35710
20	189	393	732	1496	2299	4331	7046	12510	25520
30	152	315	590	1212	1858	3465	5695	10110	20620
40	129	267	504	1039	1559	2992	4778	8481	17300
50	114	237	448	913	1417	2646	4343	7708	15730
60	103	217	409	834	1275	2394	3908	6936	14150
70	89	185	346	724	1086	2047	3329	5908	12050
80	78	162	307	630	976	1811	2991	5309	10830
90	69	146	275	567	866	1606	2654	4711	9613
100	63	132	252	511	787	1496	2412	4281	8736
125	54	112	209	439	665	1282	2083	3618	7382
150	48	100	185	390	590	1138	1808	3210	6549
175	43	90	168	353	534	1030	1637	2905	5927
200	40	83	155	325	491	947	1505	2671	5450
300	37	77	144	303	458	887	1404	2492	5084

Liquid Propane (LP) flow is given in thousands of BTU/hr. One cubic foot of NG gas - 2516 BTU.

This chart refers to low pressure LP, after regulation, standard nominal pressure at the burner for Liquid Propane Gas is 11" of water column

Pipe length must include additional length for all fittings. Add approximately 5 feet of pipe per fitting.

Liquid Propane Example: A machine with a burner that requires 440,000 BTU would need a 1" pipe for a 20' long run.

NOTE: The sizing charts above list the specific pipe sizes required for the amount of BTU's for a new gas line installations. If you are using an existing gas line you must take into consideration the existing gas line capacities to ensure you will have proper pressure.

This chart is for reference only, we recommend you consult with a Licensed Plumber/Gas Fitter or NFPA54 (National Fuel Gas Code - current edition) for more details.



The best room in the house
isn't in the house at all.



FIREGEAR

Tech & Sales | 800.966.8126

firegearoutdoors.com

14520 Delta Ln - Suite 105 | Huntington Beach | California, 92647

ver. 051922